

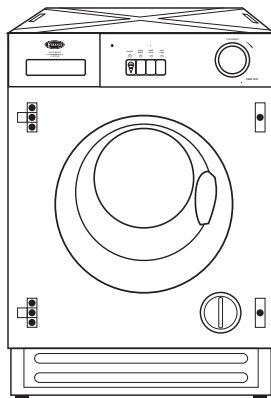

# WASHING MACHINE

## FWM 1010





# Important Safety Information

It is most important that this instruction book should be retained with the appliance for future reference. Should the appliance be sold or transferred to another owner, or should you move house and leave the appliance, always ensure that the book is supplied with the appliance in order that the new owner can get to know the functioning of the appliance and the relevant warnings.

These warnings have been provided in the interest of safety. You **MUST** read them carefully before installing or using the appliance.

## Installation

- This appliance is heavy. Care should be taken when moving it.
- It is dangerous to alter the specifications or attempt to modify this product in any way.
- All packing and transit bolts must be removed before use. Serious damage can occur to the product and to property if this is not adhered to. See relevant section in instructions.
- Any plumbing work required to install this appliance should be carried out by a qualified plumber or competent person.
- Any electrical work required to install this appliance should be carried out by a qualified electrician or competent person.
- Care must be taken to ensure that the appliance does not stand on the electrical supply cable.
- If the machine is situated on a carpeted floor, please adjust the feet in order to allow air to circulate freely
- Always be sure, that there is no water leakage from hoses and their connections after the installation.

## Child Safety

- This appliance is designed to be operated by adults. Children should not be allowed to tamper with the controls or play with the product.
- Pets and children have been known to climb into washing machines. Please check your drum before use.
- The glass door becomes very hot during the washing cycle. Keep children away from the vicinity of the appliance whilst it is in operation.
- Keep all packaging well away from children.
- Keep all detergents in a safe place out of children's reach.

## Use

- Always unplug the appliance and turn off the water

supply after use.

- Do not overload the appliance. See relevant section in the instruction book.
- Only wash fabrics which are designed to be machine washed. If in doubt, consult the care label on the clothes.
- Before washing, ensure that all pockets are empty and buttons and zips are fastened. Avoid washing frayed or torn articles and treat stains such as paint, ink, rust, and grass before washing. Underwired bras must NOT be machine washed.
- Any objects such as coins, safety pins, nails, screws, stones or any other hard, sharp material can cause extensive damage and must not be placed into the machine.
- Garments which have been in contact with volatile petroleum products should not be machine washed. If volatile cleaning fluids are used, care should be taken to ensure that the fluid is removed from the garment before placing in the machine.
- Wash small items such as socks, laces, washable belts etc in a washing bag or pillow case as it is possible for such items to slip down between the tub and the inner drum.
- Only use the advised quantities of fabric softener. Damage to the fabric can ensue if you over-fill. Refer to the manufacturer's recommendations of quantities.
- As some duvets and eiderdowns should be washed in large commercial machines because of their bulk, please check with the manufacturer of the item before washing in a domestic machine.
- Leave the porthole door slightly ajar between washes to preserve the door seal.
- Under no circumstances should you attempt to repair the machine yourself. Repairs carried out by inexperienced persons may cause injury or serious malfunctioning. Contact your local Service Centre. Always insist on genuine spare parts.

# Contents

|  |       |                                    |       |
|--|-------|------------------------------------|-------|
| <b>For the User</b>                          |       |                                    |       |
| <b>Important Safety Information</b>          | 2     |                                    |       |
| <b>Your New Washing Machine</b>              | 4     |                                    |       |
| <b>Description of the Appliance</b>          | 5     |                                    |       |
| Detergent dispenser drawer                   | 5     |                                    |       |
| Child Safety Feature                         | 5     |                                    |       |
| <b>The Control Panel</b>                     | 6     |                                    |       |
| <b>Operating sequence</b>                    | 7-10  |                                    |       |
| <b>Washing 5 kg of white cotton at 95°C</b>  | 7     |                                    |       |
| Load the laundry                             | 7     |                                    |       |
| Measure out the detergent                    | 7     |                                    |       |
| Measure out the fabric softener              | 7     |                                    |       |
| Select the required option                   | 7     |                                    |       |
| Select the required programme                | 7     |                                    |       |
| Start the machine                            | 8     |                                    |       |
| At the end of the programme                  | 8     |                                    |       |
| <b>Washing 2 kg of mixed fabrics at 50°C</b> | 9     |                                    |       |
| Load the laundry                             | 9     |                                    |       |
| Measure out the detergent                    | 9     |                                    |       |
| Measure out the fabric softener              | 9     |                                    |       |
| Select the required option                   | 9     |                                    |       |
| Select the required programme                | 9     |                                    |       |
| Start the machine                            | 9     |                                    |       |
| At the end of the programme                  | 10    |                                    |       |
| <b>Washing Hints</b>                         | 11-12 |                                    |       |
| Which detergent?....                         | 12    |                                    |       |
| And in which form?                           | 12    |                                    |       |
| <b>Wash Care Symbols</b>                     | 13    |                                    |       |
| <b>Washing Programmes</b>                    | 14-15 |                                    |       |
|  |       | <b>Maintenance and Cleaning</b>    | 16-17 |
|  |       | Descaling                          | 16    |
|  |       | After each wash                    | 16    |
|  |       | Maintenance Wash                   | 16    |
|  |       | External cleaning                  | 16    |
|  |       | Cleaning the dispenser drawer      | 16    |
|  |       | Cleaning the drawer recess         | 16    |
|  |       | Cleaning the filter                | 16-17 |
|  |       | The dangers of freezing            | 17    |
|  |       | Emergency emptying out             | 17    |
|  |       | <b>Something Not Working</b>       | 18-19 |
|  |       | <b>Service and Spare Parts</b>     | 19    |
|  |       | <b>Guarantee Conditions</b>        | 20    |
|  |       | <b>For the Installer</b>           |       |
|  |       | <b>Installation Instructions</b>   | 21    |
|  |       | <b>Technical Specifications</b>    | 21    |
|  |       | Unpacking                          | 22    |
|  |       | Positioning                        | 22    |
|  |       | Water inlet                        | 23    |
|  |       | Water drainage                     | 23-24 |
|  |       | Levelling                          | 24    |
|  |       | Special conditions                 | 24    |
|  |       | In the interest of the environment | 24    |
|  |       | Electrical connection              | 25    |
|  |       | Building-in                        | 26-27 |

## Guide to use the Instruction Book

The following symbols will be found in the text to guide you throughout the instructions:



**Safety instructions**



**Hints and tips**



**Environmental information**

# Your New Washing Machine

Your new washing machine meets all modern requirements for effective treatment of laundry with low water, energy and detergent consumption.

- **Automatic cooling of the wash water to 60°C** before draining, with the 95°C programme. This reduces thermal shock to fabrics, helping to prevent creasing.
- **The special wool programme** with its new delicate wash system treats your woollens with extreme care.
- **The balance control device** ensures that the machine remains stable when spinning.



## Ecological hints

To save water and energy and help protect the environment, we recommend that you follow these hints:

- Adjust the quantity of detergent according to the hardness of your water supply, the amount of laundry and the degree of soiling.
- A programme without prewash is sufficient for normally soiled laundry.
- The machine works more economically if it is fully loaded.
- With adequate pre-treatment, stains and limited soiling can be removed; the laundry can then be washed at a lower temperature, so saving energy.
- Select the “quick” option for lightly soiled laundry.

## In the interest of the environment

- Materials marked with the symbol  are recyclable.
- Check with your local Council or Environmental Health Office to see if there are facilities in your area for re-cycling this appliance.
- When the appliance is to be scrapped, cut off the power supply cable and make the door lock device unusable to prevent young children from being trapped inside.
- Help to keep your country tidy - use authorised disposal sites for your old appliance.

 The symbol  on the product or on its packaging indicates that this product may not be treated as household waste. Instead it shall be handed over to the applicable collection point for the recycling of electrical and electronic equipment. By ensuring this product is disposed of correctly, you will help prevent potential negative consequences for the environment and human health, which could otherwise be caused by inappropriate waste handling of this product. For more detailed information about recycling of this product, please contact your local city office, your household waste disposal service or the shop where you purchased the product.

**How do we help to protect the environment?  
We use recycled paper!**

## Important



Your machine is fitted with a balance control device, which ensures the machine is stable during the spin. If the wash load appears not to have been spun sufficiently at the end of the wash cycle, because it is not evenly distributed in the drum, the balance control device may have operated. It will therefore be necessary to redistribute the wash load manually and select a spin programme. For more detailed information see the section headed "Something Not Working".

# Description of the Appliance

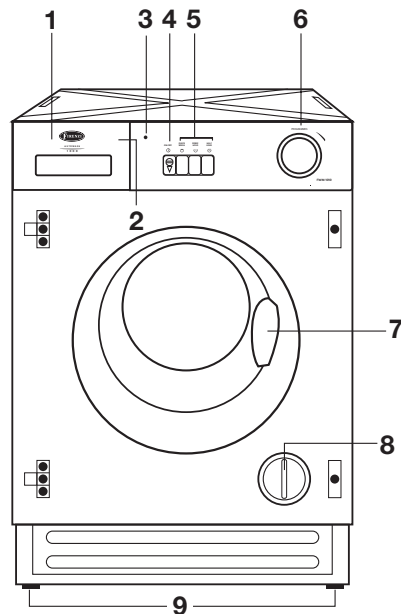
- 1 Detergent dispenser drawer
- 2 Programme guide
- 3 "Mains-on" light
- 4 ON/OFF button
- 5 "Option" buttons
- 6 Programme selector dial
- 7 Door opening handle
- 8 Filter
- 9 Adjustable feet



## Detergent dispenser drawer

-  Prewash
-  Main wash
-  Fabric softener

The programme chart is in the interior part of the drawer.

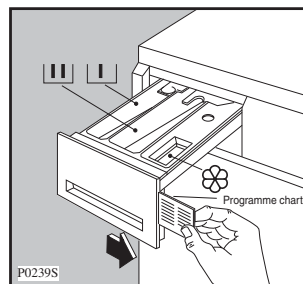

## Child safety feature

This machine incorporates a special child safety feature to prevent small children from being trapped inside the machine.

To activate this device, rotate the button (without pressing it) inside the door clockwise until the groove is horizontal. If necessary use a coin.

To disable this device and restore the possibility of closing the door, rotate the button anti-clockwise until the groove is vertical.

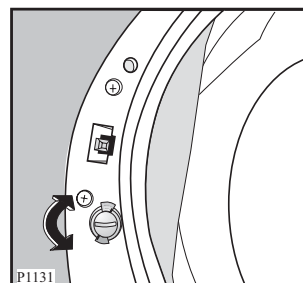

# The Control Panel

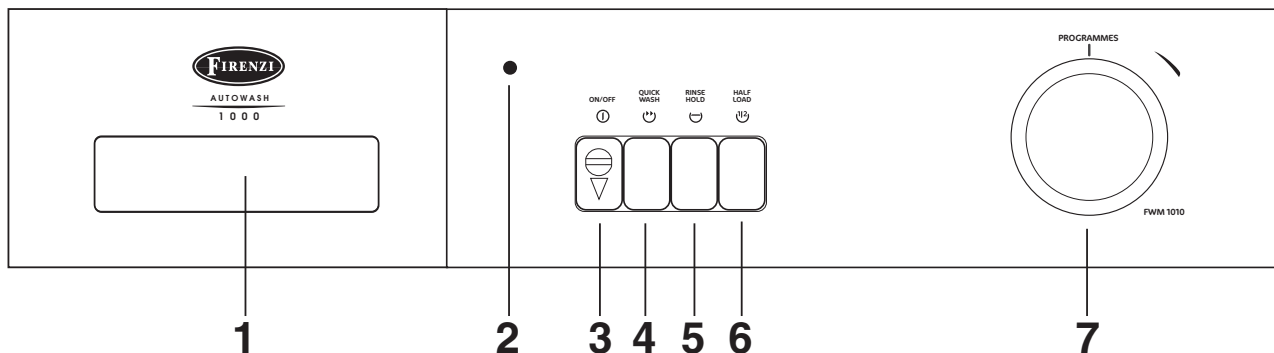

## 1 Detergent dispenser drawer

The programme chart is in the interior part of the drawer.

## 2 Mains-on light

This light illuminates when the machine starts working and goes out when the ON/OFF button is released.

## 3 ON/OFF button

By depressing this button the machine starts operating. When depressed again, the machine stops.

The push button is provided with a child-proof safety lock. Move the small slider placed in the middle of the button downwards to lock the button in the «off» position.

## 4 QUICK WASH button

By depressing this button on programmes **A, B, C, D** (Cottons - Linens) and **G** (Synthetics-Mixed fabrics) the wash time is reduced.

This is only suitable for garments which are lightly soiled.

## 5 RINSE HOLD button

Press this button to make the machine stop with water in the drum after the cotton, synthetic/mixed fabrics, wool or delicate wash cycles.

This prevents any creasing which may occur if the clothes are left damp in the drum.

When it is convenient for you to empty the machine, simply **press this button again** so that the machine can proceed to drain and spin, or select the drain programme 'P'.

If this button is not activated, the washing programmes will end with a spin.

## 6 HALF LOAD button

Select this button to reduce water consumption on the rinse cycle when washing a smaller load of cottons or linens (maximum load size = 2.5 kg).

## 7 Programme selector dial

Push the dial to pop it out. Turn the dial **clockwise** to select the required wash programme.

Before setting the dial to any position the machine must be switched off by depressing the ON/OFF  button again.

# **i** Operating Sequence

Before the first wash, we recommend that you run a cotton cycle at 95°C, without any laundry in the machine, to remove any manufacturing residue from the drum and tub.

Pour 1/2 a measure of detergent into the dispenser drawer and start the machine.

## **WASHING 5 KG OF WHITE COTTON AT 95°C**

Suppose you have 5 kg of laundry to wash. It is white cotton and is suitable for high temperature washing.

### **1. Load the laundry**

Open the door by pulling the door handle outwards. Place the laundry in the drum, one item at a time, shaking them out as much as possible. Close the door.

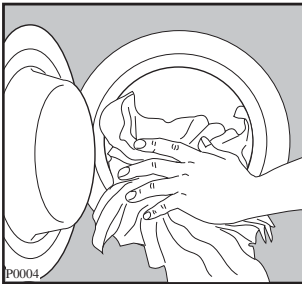

### **2. Measure out the detergent**

Pull out the dispenser drawer until it stops. Measure out the amount of detergent required and pour it into the main wash compartment .

If you wish to carry out the prewash, pour detergent into the compartment marked .

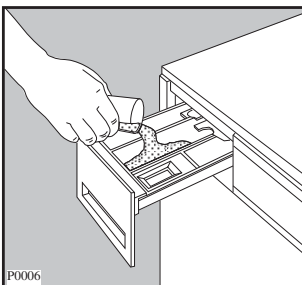



### **3. Measure out the fabric softener**

If required, pour fabric softener into the compartment marked  (the amount used must not exceed the “MAX” mark in the drawer).

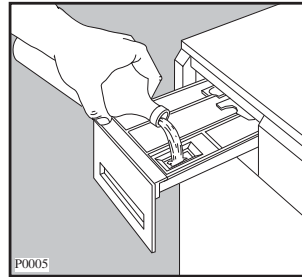
Close the drawer gently.



### **4. Select the required option**

Depress RINSE HOLD  or QUICK WASH  button, if your laundry is lightly soiled.

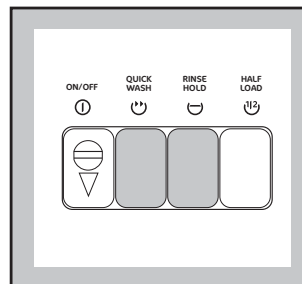

### **5. Select the required programme**

Push the programme selector dial to pop it out and turn it **clockwise** to the programme **B** or **A** (if you wish to perform a prewash).

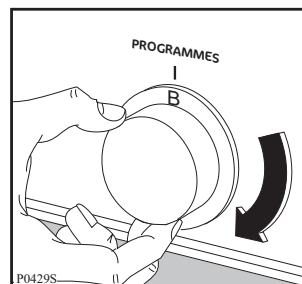

## 6. Start the machine

Before starting up the machine check that:

- the appliance is plugged in
- the water supply tap is turned on
- the drain hose is correctly and securely positioned
- the door and the detergent dispenser drawer are closed.

Depress the ON/OFF  button: the mains-on light will illuminate and the machine starts operating.

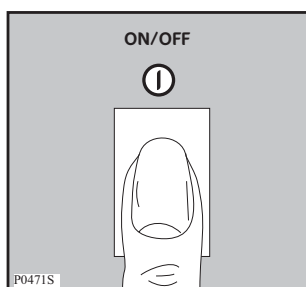

## 7. At the end of the programme

The machine stops automatically.

If you have depressed the RINSE HOLD  button, the machine will stop with the water left in the tub, to prevent the fabric from creasing.

To drain the water and spin, release the same button.

To drain only, select programme “P”.

The door is controlled by a safety device which releases 2 minutes after the end of the programme.

Switch the machine off by depressing the ON/OFF  button again. The mains-on light goes out.

When the programme has finished you are advised to unplug the appliance and turn off the water tap.

Remove the laundry from the drum and carefully check that the drum is empty.

If you do not intend to carry out another wash, close the water tap. Leave the door open to prevent the formation of mildew and unpleasant smells.



## WASHING 2 KG OF MIXED FABRICS AT 50°C

Suppose you have 2 kg of Mixed fabrics to wash. They are rather delicate fabrics and should not be washed at a high temperature.

### 1. Load the laundry

Open the door by pulling the door handle outwards. Place the laundry in the drum, one item at a time, shaking them out as much as possible. Close the door.

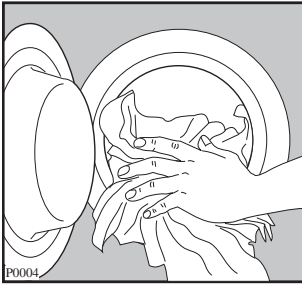

### 2. Measure out the detergent

Pull out the dispenser drawer until it stops. Measure out the amount of detergent required and pour it into the main wash compartment .

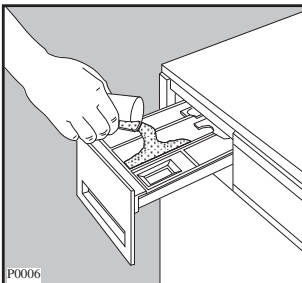

### 3. Measure out the fabric softener

If required, pour fabric softener into the compartment marked  (the amount used must not exceed the "MAX" mark in the drawer). Close the drawer gently.

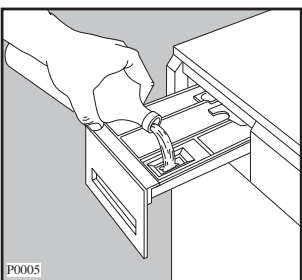

### 4. Select the required option

Depress RINSE HOLD  or QUICK WASH  button, if required.

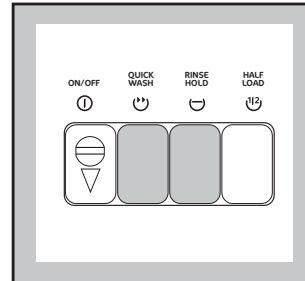

### 5. Select the required programme

Push the programme selector dial to pop it out and turn it **clockwise** to the programme **G**.

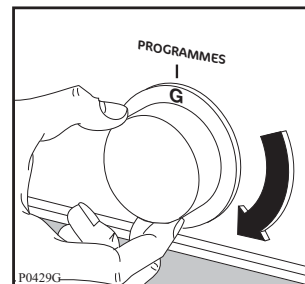

### 6. Start the machine

Before starting up the machine check that:

- the appliance is plugged in
- the water supply tap is turned on
- the drain hose is correctly and securely positioned
- the door and the detergent dispenser drawer are closed.

Depress the ON/OFF  button: the mains-on light will illuminate and the machine starts operating.

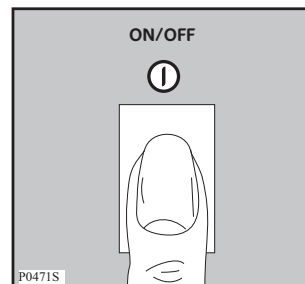

## 7. At the end of the programme

The machine stops automatically.

If you have depressed the RINSE HOLD  button, the machine will stop with the water left in the tub, to prevent the fabric from creasing.

To drain the water and spin, release the same button.

**To drain only**, select the drain programme “**P**”.

The door is controlled by a safety device which releases 2 minutes after the end of the programme.

Switch the machine off by depressing the ON/OFF  button again. The mains-on light goes out.

Remove the laundry from the drum and carefully check that the drum is empty.

When the programme has finished you are advised to unplug the appliance and turn off the water tap.

# Washing Hints

Do **NOT** overload the machine. Weigh the laundry the first few times you use the appliance.

The average weights of the most common items are listed below as a guide:

**1000g = 1 kg**

|                      |             |
|----------------------|-------------|
| Sheet                | 700-1000 g  |
| Pillow case          | 100-200 g   |
| Tablecloth           | 400-500 g   |
| Serviette            | 50-100 g    |
| Tea towel            | 70-120 g    |
| Linen hand towel     | 100-150 g   |
| Towelling hand towel | 150-250 g   |
| Towelling bath towel | 700-1000 g  |
| Bath robe            | 1000-1500 g |
| Man's shirt          | 200-300 g   |
| Apron                | 150-200 g   |

- Load the laundry loosely alternating large items with small ones.
- Sort the laundry according to the type of fabric, colour-fastness and how dirty it is.
- Avoid washing unhemmed or torn items as they may unravel.
- Before washing, empty all pockets of small objects which may have been left inside (coins, keys, screws etc). as these could damage the drain pump.
- When washing curtains, remove the hooks.
- Close poppers and zips and fasten loose buttons.
- It is essential to wash new coloured items separately when washing for the first time.
- When washing fabrics requiring different wash temperatures together, always select the lowest temperature.
- White items should not be washed with coloured items.
- Very small items (handkerchiefs, ribbons, socks etc) should be washed in a washing bag or a pillow case.
- Use a good quality detergent suitable for automatic washing machines.
- Use the correct quantities of detergent.
- For wool, use gentle detergent only in small quantities.
- Bleach is very corrosive; it should be used with care and kept out of reach of children.
- Some stains such as fruit, wine, grass, rust etc. are difficult to remove and should be treated before washing with specific products, which can be found in most household shops. In some cases it may help to soak the stain before washing with a special pre-soak product or biological detergent.
- Only wool marked "Pure New Wool - washable, preshrunk" can be washed in the machine using the wool programme; other types of wool should be washed by hand or dry cleaned.
- If you have used the machine to wash, rinse or spin only non-colour fast garments, there may be dye left in the sump. To ensure any subsequent wash is not contaminated with the dye, select and carry out a rinse and spin programme, without any garments, to ensure that any dye is removed from the sump.
- Once you have finished using the machine, you are advised to unplug it and turn off the water taps.

## Which detergent?....

To ensure you obtain the best wash results from your appliance, it is important to use the right detergent in your everyday wash, and only detergents recommended for use in automatic machines.

To maintain the appearance of your clothes and household textiles and to make them last longer you should use different types of detergent for different washes, whether for whites, colours or delicates.

### WHITES

We recommend the Ariel product range which is biological and designed to provide excellent cleaning and stain removal even at low temperatures.



### NON BIOLOGICAL

If you prefer to use a non biological detergent, which does not contain enzymes we recommend Fairy. Fairy provides good cleaning and stain removal.



### COLOURS

For coloured items you should use a detergent which is designed to clean while maintaining the original colour. Ariel Color does not contain bleach and therefore helps to preserve colours.



### DELICATE ITEMS

When washing delicates such as woollens, you should use a product which is specially designed to care for fine fabrics.

Dreft Automatic is suitable for woollens and other delicates.



### LAUNDRY BLEACH

For additional stain removal you may wish to use a product such as Ace Gentle Bleach which is used in addition to your chosen detergent. Ace is suitable for all washable fabrics including silks, woollens and colours.



## And in which form?

Not only are there different types of detergent, but they are also available in different forms. Whether you chose a powder or liquid in traditional or compact form is your own personal choice.

### TRADITIONAL POWDERS

Pour the powder directly into the dispenser drawer. Do not sprinkle powder onto clothes in the machine drum.

### TRADITIONAL LIQUIDS

Liquid can be placed in the main wash compartment of the detergent drawer marked with the symbol , start the machine immediately upon placing the detergent in the dispenser drawer.

Alternatively the detergent is measured into the specially designed dosing device\* which should be placed on top of the laundry, and at the back of the machine drum.

### COMPACT POWDERS AND LIQUIDS

Compact detergents (or concentrates as they are also known) are available in liquid or powder form, and generally require a smaller dosage. Follow the manufacturer's instructions to ensure the most economical usage. Pour the detergent directly into the dispenser drawer, or alternatively measure the detergent into the specially designed dosing device\* which should be placed on top of the laundry, and at the back of the machine drum.

\* **If you use a dosing device in a washer dryer, please ensure the dosing device/ball is removed before carrying out a drying programme.**

### FABRIC CONDITIONERS

These are ideal for improving 'softness', and also reduce static cling on synthetics and make ironing easier. They are available in two types:

For example Lenor liquid fabric softener, for use in the **washing machine/washer dryer**. The liquid fabric softener should be poured into the compartment marked with the symbol . Follow the manufacturer's dosage instructions and never exceed the MAX level.

















Bounce conditioning sheets for use in a **tumble dryer**. We recommend the conditioning sheets are pinned (using a safety pin) to an article of laundry and placed in the tumble dryer.



# Wash Care Symbols

Wash care labels inside garments recommend how to launder your clothes with the best results. The care labelling code is in line with care labelling used in the rest of Europe. The symbols used make it easy to select the correct programme on your washing machine.

| WASHING SYMBOL  | WASH ACTION  | FABRIC   |
|---|--|--|
|    | Normal (Maximum)   | White Cotton or Linen without Special Finishes                                 |
|    | Normal (Maximum)   | Cotton, Linen or Viscose without Special Finishes<br>Colourfast at 60°C.       |
|    | Reduced (Medium)   | Nylon, Polyester/Cotton, Viscose with Special Finishes,<br>Cotton/Acrylic Mix. |
|    | Normal (Maximum)   | Cotton, Linen or Viscose<br>Colourfast at 40°C but not 60°C.                   |
|    | Reduced (Medium)   | Acrylics, Acetate, Triacetate, Wool mixes, Polyester/wool blends.              |
|    | Much Reduced (Minimum)   | Wool, wool mixtures, Silks   |
|   | Hand wash only   | Do not machine wash  |
| <b>BLEACHING</b>  |  |  |
|  | Chlorine bleach may be used  |  |
| <b>IRONING</b>  |  |  |
|  | Hot iron   | Cotton, Linen, Viscose   |
|  | Warm iron  | Polyester mixtures, Wool   |
|  | Cool iron  | Acrylic, Nylon, Polyester  |
| <b>DRY CLEANING</b>   |  |  |
|  | May be dry cleaned. Other letters and/or a bar beneath the circle will indicate the required process to the dry cleaner. |  |
| <b>TUMBLE DRYING</b>  |  |  |
|  | with high heat setting   |  |
|  | with low heat setting  |  |
|  | May be tumble dried  |  |
| <b>X</b>  | A cross through any symbol means «DO NOT»  |  |





## Important Notes

For best results, always use the dispenser drawer for dispensing detergents and liquid additives. Once the dispenser has been filled, close it by pushing it in gently. This is particularly important if you are using

fabric conditioner to avoid the conditioner entering the machine prematurely. When using liquid detergent and a prewash programme, place the detergent into the correct compartment in the dispenser drawer, after the prewash has finished.

# Washing Programmes

## Programmes for Cotton - Linens

| Wash programme/<br>Washing symbol   | Degree of soil<br>and type of laundry  | Programme<br>dial position | Description   | Possible<br>options                            | Max.<br>load | Progr.<br>time<br>mins. |
|---|--|----------------------------|---|--|--------------|-------------------------|
|  <b>Whites<br/>with prewash</b>  | For heavy soiled cotton<br>items.  | <b>A</b>                   | Prewash at 40 °C<br>Wash at 95°C<br>3 rinses<br>Long spin | <b>RINSE HOLD<br/>HALF LOAD<br/>QUICK WASH</b> | 5 kg         | 170                     |
|  <b>Whites</b>                   | White cotton, for<br>example normally soiled<br>work garments, sheets,<br>household linen,<br>underwear, towels. | <b>B</b>                   | Wash at 95 °C<br>3 rinses<br>Long spin                    | <b>RINSE HOLD<br/>HALF LOAD<br/>QUICK WASH</b> | 5 kg         | 145                     |
|  <b>Fast<br/>coloureds</b>       | Fast coloured cotton or<br>linen fabrics, shirts,<br>underwear, towels.  | <b>C(*)</b>                | Wash at 60 °C<br>3 rinses<br>Long spin                    | <b>RINSE HOLD<br/>HALF LOAD<br/>QUICK WASH</b> | 5 kg         | 140                     |
|  <b>Non fast<br/>coloureds</b> | Non fast coloured<br>cotton or linen fabrics,<br>shirts, blouses,<br>underwear.                                  | <b>D</b>                   | Wash at 40 °C<br>3 rinses<br>Long spin                    | <b>RINSE HOLD<br/>HALF LOAD<br/>QUICK WASH</b> | 5 kg         | 115                     |
| <b>Spin 1000</b>  | Separate spin for<br>cotton and linen items  | <b>F</b>                   | Long spin   |  | 5 kg         | 12                      |

(\*) This programme at 60°C with a load of 5 kg of laundry is the reference programme for the Energy label according to EEC Directive 92/75.





This data is given purely as an indication: the consumption values may vary in relation to the quantity and type of laundry, the temperature of the water supply and the ambient temperature. The data refers to the highest temperature provided for each programme.

### Important!

- Some programmes, when selected, may start with a short drain. This is quite normal and not a fault of the machine. When a programme is selected, the selector dial will advance to the water filling position. E.g. Programme **B** is selected, there is a short drain. The appliance takes in water and the selector will appear to move to the **C** position. The appliance will have memorised the programme selected, in this case **B**, and will run the correct programme even though the selector dial appears to be at position **C**.
- We recommend you not to switch the appliance off and on during its operation. This would modify the memorised programme in progress with unsatisfactory washing results.

# Washing Programmes

## Programmes for Synthetics, Mixed fabrics, Wool and Delicates

| Wash programme/<br>Washing symbol  | Degree of soil<br>and type of laundry   | Programme<br>dial position | Description  | Possible<br>options                      | Max.<br>load | Progr.<br>time<br>mins. |
|--|---|----------------------------|--|--|--------------|-------------------------|
|  <b>Mixed fabrics</b>   | Synthetic or mixed fabrics, underwear, coloured garments, non-shrink shirts, blouses.                         | <b>G</b>                   | Wash at 50 °C<br>3 rinses<br>Short spin                  | <b>RINSE<br/>HOLD<br/>QUICK<br/>WASH</b> | 2 kg         | 80                      |
|  <b>Worn once</b>   | Lightly soiled synthetic or mixed fabrics   | <b>H</b>                   | Wash at 30 °C<br>3 rinses<br>Short spin                  | <b>RINSE<br/>HOLD</b>                    | 2 kg         | 30                      |
| <b>Short spin</b>  | Separate spin for hand washed delicate items  | <b>J</b>                   | Draining of water and short spin                         |  | 2 kg         | 6                       |
|  <b>Wool wash</b>  | Specially tested programme for wool garments bearing the "Pure new wool, non-shrink, machine washable" label. | <b>K</b>                   | Wash at 40 °C<br>3 rinses<br>Short spin                  | <b>RINSE<br/>HOLD</b>                    | 1 kg         | 50                      |
|  <b>Delicate wash</b>   | Delicate fabrics, for example curtains  | <b>L</b>                   | Wash at 40 °C<br>3 rinses<br>Short spin                  | <b>RINSE<br/>HOLD</b>                    | 2 kg         | 50                      |
| <b>Rinses</b>  | Separate rinse cycle for handwashed synthetic items   | <b>M</b>                   | 3 rinses<br>Short spin                                   | <b>RINSE<br/>HOLD</b>                    | 2 kg         | 18                      |
| <b>Softeners</b>   | This programme can be used for softening hand washed garments.  | <b>N</b>                   | 1 rinse, with fabric softener, if required<br>Short spin | <b>RINSE<br/>HOLD</b>                    | 2 kg         | 9                       |
| <b>Drain</b>   | For emptying out the last rinse water in programmes with the Rinse Hold option.                               | <b>P</b>                   | Draining of water  |  | -            | 1                       |

The consumption data shown on this chart is to be considered purely indicative, as it may vary depending on the quantity and type of laundry, on the inlet water temperature and on the ambient temperature.

### Important!

- Programmes **G** and **K**, when selected, may start with a short drain. This is quite normal and not a fault of the machine.
- We recommend you not to switch the appliance off and on during its operation. This would modify the memorised programme in progress with unsatisfactory washing results.

# Maintenance and Cleaning

Before any maintenance or cleaning is carried out you must **DISCONNECT** the appliance from the electricity supply.

## Descaling

The water we use normally contains lime. It is a good idea to periodically use a water softening powder in the machine. Do this separately from any laundry washing, and according to the softening powder manufacturer's instructions. This will help to prevent the formation of lime deposits.

## After each wash

Leave the door open for a while. This helps to prevent mould and stagnant smells forming inside the appliance. Keeping the door open after a wash will also help to preserve the door seal.

## Maintenance Wash

With the use of low temperature washes it is possible to get a build up of residues inside the drum. We recommend that a maintenance wash be performed on a regular basis.

### To run a maintenance wash:

- The drum should be empty of laundry.
- Select the hottest cotton wash programme.
- Use a normal measure of detergent, must be a powder (such as Ariel Futur).

## External cleaning

Clean the exterior cabinet of the appliance with soap and water only, and then dry thoroughly.

## Cleaning the dispenser drawer

The washing powder and additive dispenser drawer should be cleaned regularly. Remove the drawer by pressing the catch downwards and by pulling it out. Flush it out under a tap, to remove any traces of accumulated powder. To aid cleaning, the top part of the additive compartment should be removed.

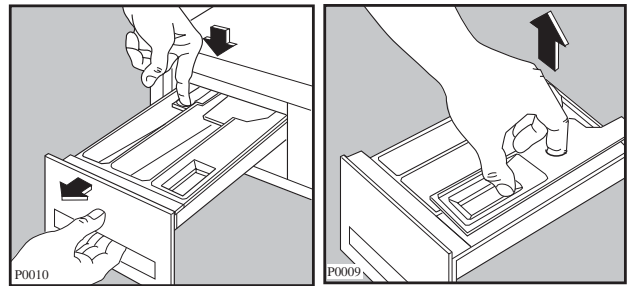

## Cleaning the drawer recess

Having removed the drawer, use a small brush to clean the recess, ensuring that all washing powder residue is removed from the upper and lower part of the recess. Replace the drawer and run the rinse programme without any clothes in the drum.

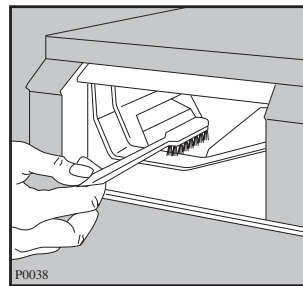

## Cleaning the filter

### The water drain filter

A clean filter is important for the correct operating of the machine, and should therefore be cleaned after every washing programme.

Place a container underneath to catch any spillage. If the filter is blocked and the machine is unable to drain you will need to drain the water manually from the machine at this stage. To do this, unhook the drain hose from the standpipe or sink and hold the end of the hose over a bowl on the floor. The water should drain by gravity into the bowl. When the bowl is full, hook the hose back up and empty the bowl. Repeat the procedure until water stops flowing out.

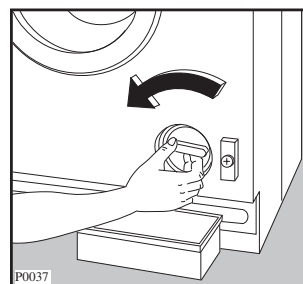



Unscrew and remove the filter.

Clean carefully under a fast running tap.

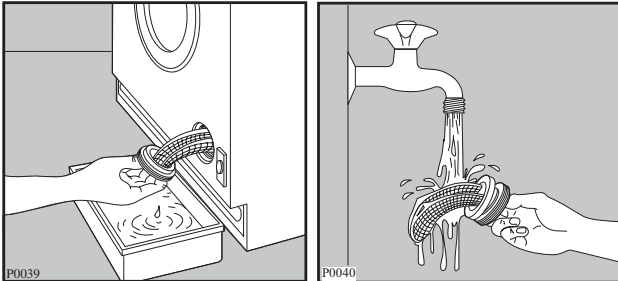

### **Warning**

When the appliance is in use and depending on the programme selected there can be hot water in the filter. Never remove the filter during a wash cycle, always wait until the appliance has finished the cycle, and is empty. When replacing the filter, ensure it is securely retightened so as to stop leaks and young children being able to remove it.

## The water inlet filter

If your water is very hard or contains traces of lime deposit, the water inlet filter may become clogged.

It is therefore a good idea to clean it from time to time.

Turn off the water tap. Unscrew the water inlet hose. Clean the filter using a hard bristle brush.

Tighten up the inlet hose.

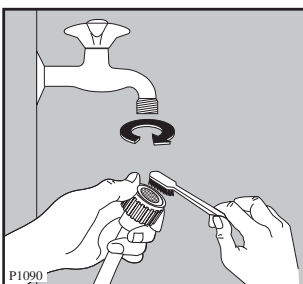

## The dangers of freezing

If the machine is exposed to temperatures below 0°C, certain precautions should be taken.

- Turn off the water tap.
- Unscrew the inlet hose.
- Unhook the drain hose from the rear support and position the end of this hose and that of the inlet hose in a bowl. Run the draining programme “P”.
- Disconnect the appliance.
- Screw the inlet hose and reposition the drain hose.
- When you intend to start the machine up again, make sure that the room temperature is above 0°C.

## Emergency emptying out

If the water is not discharged, proceed as follows to empty out the machine:

- pull out the plug from the power socket;
- close the water tap;
- if necessary, wait until the water has cooled down;
- Unscrew and remove the filter;
- place a bowl on the floor. The water should drain by gravity into the bowl. When the bowl is full, empty the bowl. Repeat the procedure until water stops flowing out;
- clean the filter if necessary as previously described;
- screw the filter again.

# Something Not Working

Certain problems are due to lack of simple maintenance or oversights, which can be solved easily without calling out an engineer. Before contacting your local Service Centre, please carry out the checks listed below.

**IMPORTANT: if you call out an engineer to a fault listed below, or to repair a fault caused by incorrect use or installation, a charge will be made even if the appliance is under guarantee.**

| Symptom  | Possible causes   |
|--|---|
| <b>The machine does not start</b>                      | <ul style="list-style-type: none"> <li>• The door has not been closed.</li> <li>• The plug is not properly inserted in the power socket.</li> <li>• There is no supply at the socket</li> <li>• The main fuse or the fuse in the plug has blown.</li> <li>• The selector dial is not correctly positioned.</li> <li>• The ON/OFF Ⓜ button has not been depressed.</li> </ul>  |
| <b>The machine does not fill</b>                       | <ul style="list-style-type: none"> <li>• Ensure the water tap is open.</li> <li>• The filter in the inlet hose is blocked.</li> <li>• The inlet hose may be squashed or kinked.</li> <li>• The door has not been closed.</li> </ul>   |
| <b>The machine fills then empties immediately</b>      | <ul style="list-style-type: none"> <li>• The end of the drain hose is too low.</li> <li>• The end of the drain hose is submerged in water.</li> <li>• There is no vent in the end of the drain hose.</li> </ul>   |
| <b>The machine does not empty and/or does not spin</b> | <ul style="list-style-type: none"> <li>• The drain hose may be squashed or kinked.</li> <li>• The RINSE HOLD  option has been selected.</li> <li>• The drain filter may be blocked.</li> <li>• The drain hose extension, if fitted, is not correct. Follow the instructions for connecting to the waste.</li> <li>• The drainage system pipes are blocked.</li> <li>• The wash load is unbalanced: redistribute the clothes inside the drum to allow the machine to spin.</li> </ul> |
| <b>There is water on the floor</b>                     | <ul style="list-style-type: none"> <li>• Too much detergent or unsuitable detergent has been used (creates too much foam).</li> <li>• Check whether there are any leaks from one of the inlet hose fittings. It is not always easy to see this as the water runs down the hose; check to see if it is damp.</li> <li>• The drain hose may be damaged or not securely positioned.</li> <li>• The detergent dispenser drawer or recess is clogged.</li> <li>• The drainage system pipes are blocked.</li> </ul>   |
| <b>Unsatisfactory washing results</b>                  | <ul style="list-style-type: none"> <li>• Too little detergent or unsuitable detergent has been used. An insufficient amount of detergent leaves the laundry looking grey and causes lime scale to form.</li> <li>• Stubborn stains have not been treated prior to washing</li> <li>• The correct wash programme has not been selected.</li> <li>• Too much laundry has been placed in the drum.</li> </ul>  |
| <b>The machine vibrates when spinning</b>              | <ul style="list-style-type: none"> <li>• The internal packing has not been removed.</li> <li>• The machine is in contact with the wall or furniture.</li> <li>• The machine is not stable and level (check diagonally).</li> <li>• The washing load is badly distributed in the drum.</li> <li>• Maybe there is very little laundry in the drum.</li> </ul>   |

| Symptom  | Possible causes   |
|--|---|
| <b>The door will not open</b>                            | <ul style="list-style-type: none"> <li>• The programme is still running.</li> <li>• The door lock has not yet released.</li> <li>• Water in the tub: the door cannot be opened if water is present in the tub.</li> </ul>   |
| <b>Spinning starts late or the machine does not spin</b> | <ul style="list-style-type: none"> <li>• The electronic unbalance detection device has cut in because the laundry is not evenly distributed in the drum. The laundry is redistributed by reverse rotation of the drum. This may happen several times before the unbalance disappears and normal spinning can resume. If, after 20 minutes, the laundry is still not evenly distributed in the drum, the machine will not spin. In this case, redistribute the load manually and reselect the spin programme.</li> </ul> |
| <b>The machine makes an unusual noise</b>                | <ul style="list-style-type: none"> <li>• The machine is fitted with a type of motor which makes an unusual noise compared with other traditional motors. This new motor ensures a softer start and more even distribution of the laundry in the drum when spinning, as well as increased stability of the machine.</li> </ul>   |
| <b>No water is visible in the drum</b>                   | <ul style="list-style-type: none"> <li>• Machines based on modern technology operate very economically using very little water without affecting performance.</li> </ul>  |

## Service & Spare Parts **SERVICE FORCE**

In the event of your appliance requiring service, or if you wish to purchase spare parts, please contact your local Service Centre by telephoning:

**0870 5 929929**

Your telephone call will be automatically routed to the Service Centre covering your post code area. For the address of your local Service Force Centre and further information about Service Force, please visit the website at [www.serviceforce.co.uk](http://www.serviceforce.co.uk).

Before calling out an engineer, please ensure you have read the details under the heading "Something Not Working".

When you contact the Service Centre you will need to give the following details:

1. Your name, address and post code
2. Your telephone number
3. Clear and concise details of fault
4. The model and serial number of the appliance (found on the rating plate - see picture).
5. The purchase date

For Customer Service in Ireland please contact us at the address below:

EHP  
Long Mile Road  
Dublin 12  
Republic of Ireland  
Tel: +353 (0)1 4090751

**In-guarantee customers should ensure that the above checks have been made as the engineer will make a charge if the fault is not a mechanical or electrical breakdown. Please note that a valid purchase receipt or guarantee documentation is required for in-guarantee service calls.**

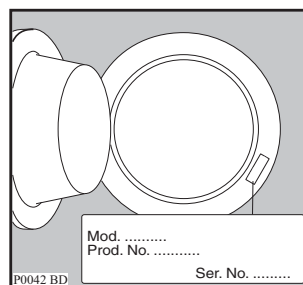

## Customer Care

For general enquiries concerning your appliance, please contact our Customer Care Department by letter or telephone as follows:

Customer Care Department - EHP  
Addington Way  
Luton  
Bedfordshire  
LU4 9QQ

Tel 08705 950 950\*

\* calls to this number may be recorded for training purposes.

# Guarantee Conditions

## Standard guarantee conditions

We, EHP, undertake that if, within 12 months of the date of the purchase, this Firenzi appliance or any part thereof is proved to be defective by reason only of faulty workmanship or materials, we will, at our option, repair or replace the same **FREE OF ANY CHARGE** for labour, materials or carriage on condition that:

- The appliance has been correctly installed and used only on the electricity supply stated on the rating plate.
- The appliance has been used for normal domestic purposes only, and in accordance with the manufacturer's instructions.
- The appliance has not been serviced, maintained, repaired, taken apart or tampered with, by any person not authorised by us.

All service work under this guarantee must be undertaken by a Service Force Centre.

Any appliance or defective part replaced shall become the Company's property.

This guarantee is in addition to your statutory and other legal rights.

Home visits are made between **8.30am** and **5.30pm** Monday to Friday. Visits may be available outside these hours in which case a **premium** will be charged.

## Exclusions

### This guarantee does not cover:

- Damage or calls resulting from transportation, improper use or neglect, the replacement of any light bulbs or removable parts of glass or plastic.
- Costs incurred for calls to put right an appliance which is improperly installed or calls to appliances outside the United Kingdom.
- Appliances found to be in use within a commercial environment, plus those which are subject to rental agreements.

## European guarantee

If you should move to another country within Europe then your guarantee moves with you to your new home subject to the following qualifications:

- The guarantee starts from the date you first purchased your product.
- The guarantee is for the same period and to the same extent for labour and parts as exists in the new country of use for this brand or range of products.
- The guarantee relates to you and cannot be transferred to another user.
- Your new home is within the European Community (EC) or European Free Trade Area.
- The product is installed and used in accordance with our instructions and is only used domestically, i.e. a normal household.
- The product is installed taking into account regulations in your new country.

Before you move please contact your nearest Customer Care Centre, listed below, to give them details of your new home. They will then ensure that the local Service Organisation is aware of your move and able to look after you and your appliances.

|         |           |                     |
|---------|-----------|---------------------|
| France  | Senlis    | +33 (0)344 62 20 13 |
| Germany | Nurnberg  | +49 (0)800 234 7378 |
| Italy   | Pordenone | +39 (0)800 11 75 11 |
| Sweden  | Stockholm | +46 (0)20 78 77 50  |
| UK      | Luton     | +44 (0)8705 950 950 |
| Ireland | Dublin    | +353 (0)1 40907528  |

# Installation Instructions

- ⚠ It is dangerous to alter the specifications or attempt to modify this product in any way.
- ⚠ Care must be taken to ensure that the appliance does not stand on the electrical supply cable.
- ⚠ Any electrical work required to install this appliance should be carried out by a qualified electrician or competent person.
- ⚠ Any plumbing work required to install this appliance should be carried out by a qualified plumber or competent person.
- ⚠ Should the appliance power supply cable need to be replaced, this should be carried out by our Service Force Centre.

# Technical Specifications

|   |   |                                   |
|---|---|-----------------------------------|
| DIMENSIONS  | Height<br>Width<br>Depth                                | 82 cm<br>60 cm<br>54 cm           |
| POWER SUPPLY VOLTAGE<br>TOTAL POWER ABSORBED  |   | 230-240 V/50 Hz<br>2050 W (10A)   |
| WATER PRESSURE  | Minimum<br>Maximum                                      | 0.05 MPa<br>0.8 MPa               |
| MAX LOAD CAPACITY   | Cotton, linen<br>Synthetics<br>Delicate fabrics<br>Wool | 5 kg<br>2 kg<br>2 kg<br>1 kg      |
| SPIN SPEED  | Maximum   | 1000 rpm                          |
| CONSUMPTION DATA FOR WASHING<br>5 KG NORMALLY SOILED COTTON<br>ITEMS AT 60°C (PROGR. C) | Energy<br>Water<br>Time                                 | 1.15 kWh<br>59 litres<br>140 mins |

- CE** This appliance complies with the following E.E.C. Directives:
- 73/23 EEC of 19.2.73 (Low Voltage Directive) and subsequent modifications;
  - 89/336 EEC of 3.5.89 (Electromagnetic Compatibility Directive) and subsequent modifications.

## Unpacking

 All transit bolts and packing must be removed before using the appliance.

You are advised to keep all the packaging for re-use in case the machine is to be transported again.

Using a spanner unscrew and remove the rear right bolt. Lay the machine gently on its back, making sure that the hoses are not squashed.

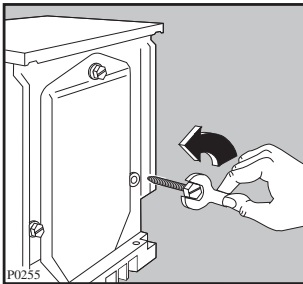

Remove the polystyrene base and take off the bottom panel by unscrewing the central screw. Carefully slide out the right polythene bag.

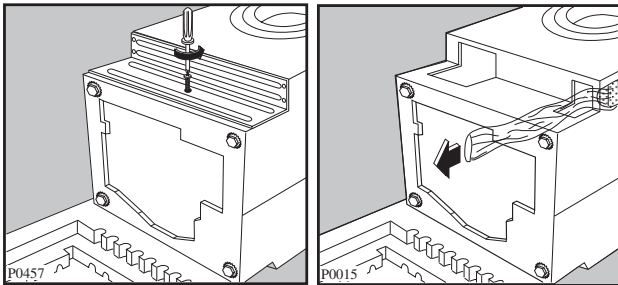

Repeat the operation for the left and central polythene bags.

Re-fit the bottom panel using the 4 screws supplied with the door hinges (in the plastic bag) and the previously removed screw.

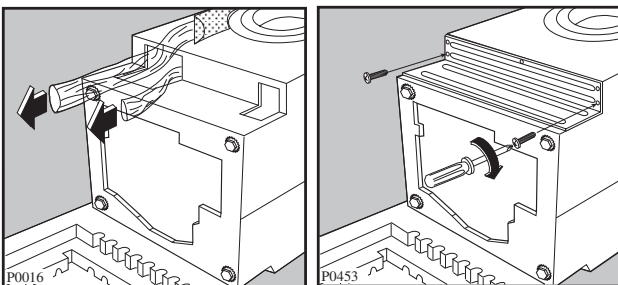

Set the machine upright and remove the two remaining bolts from the back.

Pull out the three plastic spacers from the holes into which the bolts were fitted.

Plug the open holes with the plugs supplied with the instruction booklet.

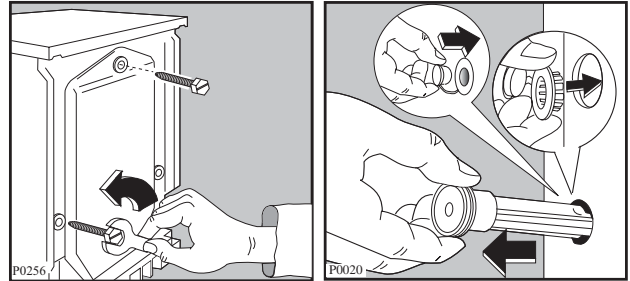

### Important !

**You are advised to keep all the packaging for re-use in case the machine is to be transported again.**

**In case of moving out the same precautions as per paragraph "The dangers of freezing" must be taken i.e. the residual water in the hoses must be pumped out.**

## Positioning

Install the machine on a flat hard floor.

Make sure that air circulation around the machine is not impeded by carpets, rugs etc. Check that the machine does not touch the wall or other kitchen units.

Never place cardboard, wood or similar materials under the machine to compensate for any unevenness in the floor.

Your new washing machine has been designed to be permanently plumbed in to your home's water supply and drainage system. However, if this is not possible, it may be connected to suitable existing taps with the drain hose discharging into a sink.

The appliance has one inlet hose, with a female 3/4" BSP thread connector.

If this connection is not compatible with the plumbing of the existing installation, a variety of connectors are available from good hardware stores and plumbers merchants to suit most domestic plumbing. Any alteration to your existing plumbing must be carried out by a competent person, or qualified plumber.

## Installation on a Suspended Floor

Suspended wooden floors are particularly susceptible to vibration. To help prevent vibration we recommend you place a waterproof wood panel, at least 15 mm thick under the appliance, secured to at least 2 floor beams with screws. If possible install the appliance in one of the corners of the room, where the floor is more stable.

## Water inlet

Connect the hose to a tap with a 3/4" thread.  
Do not use previously used hoses for water connection.

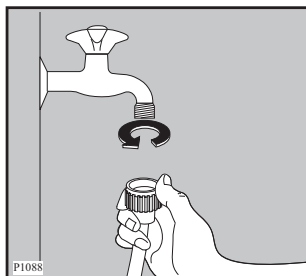

Installation should comply with local water authority and building regulations' requirements.

### The appliance must be connected to a cold water supply.

A minimum water pressure of 0.05 MPa (0.5 bar) is required for safe operation of the appliance.

If you cannot make the cold water connection direct from the rising mains, you may be able to operate the appliance from your cold water storage system.

There should be a minimum distance of 5.02m (16.5 ft) between the appliance's inlet and the bottom of the water storage tank.

Set the hose correctly by loosening the ring nut. After positioning the inlet hose, be sure to tighten the ring nut again to prevent leaks.

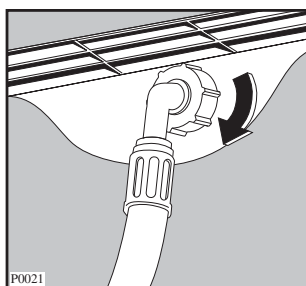

## Water drainage

This appliance is designed to be permanently plumbed into your home's drainage system using one of the following methods.

### 1. Into a drainage standpipe.

Firstly form a hook in the end of the drain hose using the "U" piece supplied.

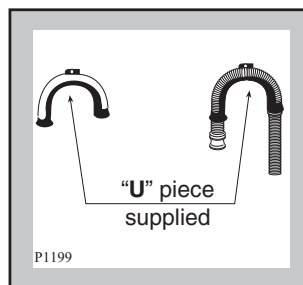

Place the drain hose into your standpipe, which should have an internal diameter of approximately 38mm thus ensuring there is an air break between the drain hose and standpipe.

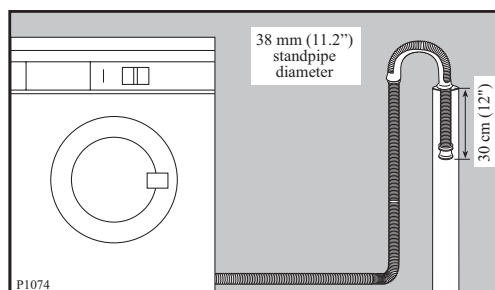

When discharging into a standpipe ensure that the top of the standpipe is no more than 90cm (35.4") and no less than 60cm (23.6") above floor level.

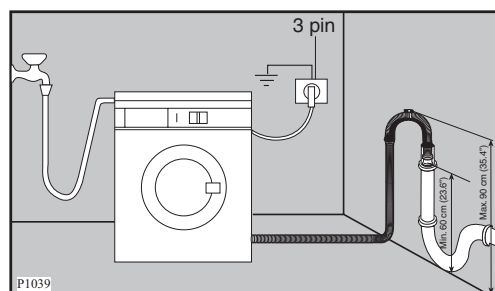

The drain hose may be extended to a maximum of 4 metres. An additional drain hose and joining piece is available from your local Service Force Centre. The joining piece must have an internal diameter of 18mm.

If your drain hose looks like this (see below) you do not require the "U" piece". Just push the hose firmly into the standpipe.

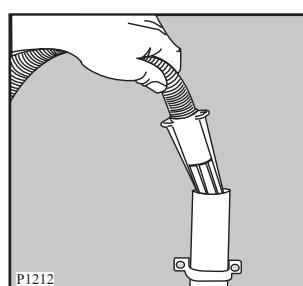

## 2. Onto a sink outlet spigot.

If the outlet spigot has not been used before, remove any blanking plug that may be in place.

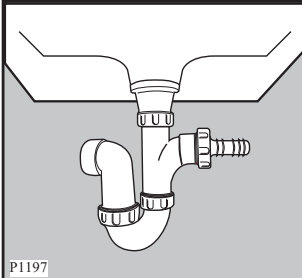

Push the drain hose onto the spigot and secure with a clip if required, ensure a loop is formed in the drain hose (see diagram) to prevent waste from the sink entering the washing machine.

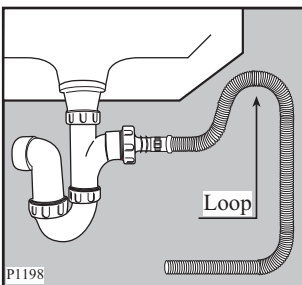

The drain hose may be extended to a maximum of 4 metres. An additional drain hose and joining piece is available from your local Service Force Centre. The joining piece must have an internal diameter of 18mm.

### Important

- Before connecting the machine to new pipework or to pipework that has not been used for some time, run off a reasonable amount of water to flush out any debris that may have collected in the pipes.

### Levelling

Level the appliance by raising or lowering the feet. The feet may be tight to adjust as they incorporate a self locking nut, but the machine **MUST** be level and stable.

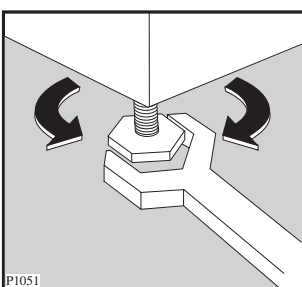

Any necessary adjustment can be made with a spanner. Accurate levelling prevents vibration, noise and displacement of the machine during operation. Some vibration is inevitable, especially if mounted on a wooden floor.

Sprung wooden floors are particularly susceptible to vibration. For advice, consult a builder. If possible, always place the machine on a solid floor.

### Special conditions

If the floor is carpeted or covered with crumbly or soft material, insert a rigid support base under the feet to prevent noise, vibration or displacement. The base should protrude a few centimetres beyond the edges of the machine.

### ⚠ Warning

The machine should **NOT** be placed on deep pile carpeting.

### Note

Please ensure that when the appliance is installed it is easily accessible for the engineer in the event of a breakdown.

### In the interest of the environment

Washer-dryers and dishwashers should be connected to the FOUL drainage system, the water will then be taken to a sewage works for treatment before being discharged safely into a river.

It is essential that these appliances are not connected to the surface water drainage system as this water is discharged directly into a river or stream and may cause pollution.

If you require any further advice please contact your local water authority.

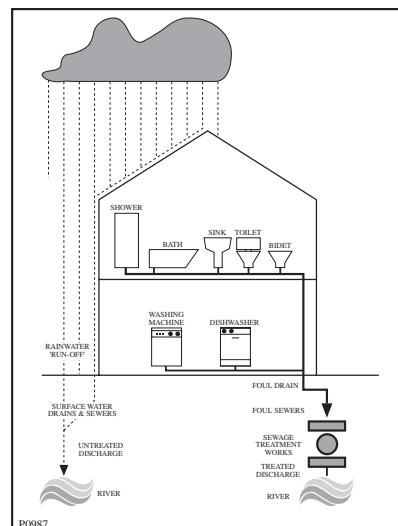



## Electrical connection

Any electrical work required to install this appliance should be carried out by a qualified electrician or competent person.

**! WARNING: THIS APPLIANCE MUST BE EARTHED.**

**The manufacturer declines any liability should this safety measure not be observed.**

Before switching on, make sure the electricity supply voltage is the same as that indicated on the appliance's rating plate. The rating plate is located at the top of the rim of the open door.

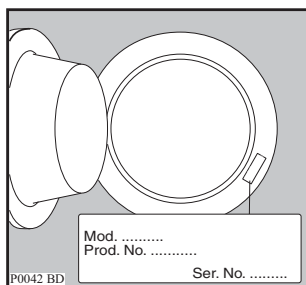

The appliance is supplied with a 13amp plug fitted. In the event of having to change the fuse in the plug supplied, a 13amp ASTA approved (BS1363/A) fuse must be used.

Should the plug need to be replaced for any reason, proceed as described below.

The wires in the mains lead are coloured in accordance with the following code:

|                  |           |
|------------------|-----------|
| Green and Yellow | - Earth   |
| Blue             | - Neutral |
| Brown            | - Live    |

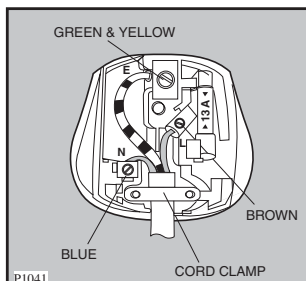

The wire coloured green and yellow must be connected to the terminal marked with the letter «E» or by the earth symbol  $\perp$  or coloured green and yellow.

The wire coloured blue must be connected to the terminal marked «N» or coloured black.

The wire coloured brown must be connected to the terminal marked «L» or coloured red.

Upon completion there must be no cut, or stray strands of wire present and the cord clamp must be secure over the outer sheath.

**! WARNING:**  
**A cut off plug inserted into a 13 amp socket is a serious safety (shock) hazard. Ensure that the cut off plug is disposed of safely. Should the appliance power supply cable need to be replaced, this MUST be carried out by our Service Centre.**

### Note

When the appliance is installed the power supply cable must be accessible.

## Permanent connection

In the case of permanent connection it is necessary that you install a double pole switch between the appliance and the electricity supply (mains), with a minimum gap of 3mm between the switch contacts and of a type suitable for the required load in compliance with the current electrical regulations.

The switch must not break the yellow and green earth cable at any point.

## Building-in

This appliance has been designed to be built into the kitchen furniture.

The recess should have the dimensions shown in picture A.

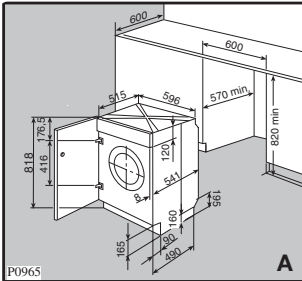

When installing the appliance into the kitchen furniture ensure, if possible, the hoses are placed in either of the two recesses on the back of the appliance. This will help to prevent the hoses from becoming kinked or trapped. Picture AB.

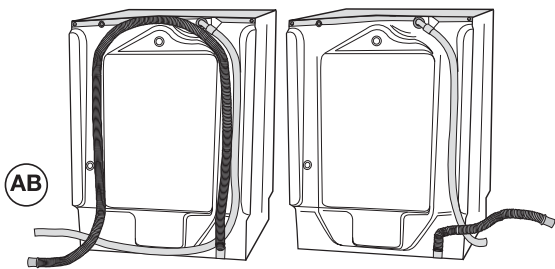

## Preparation and assembly of the door

The machine is originally pre-arranged for the assembly of a door opening from right to left.

In this case it is sufficient to screw in the hinges (1) and the counter-magnet (6) provided with the appliance, at the right level (Fig. B).

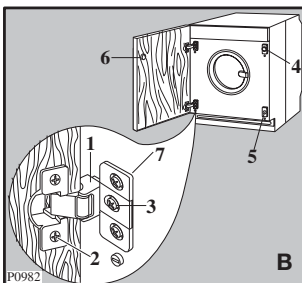

### a) Door

The dimensions of the door should be:

- width 595-598 mm
- thickness 16-22 mm

The height (C-Fig. C) depends on the height of the adjacent furniture's base.

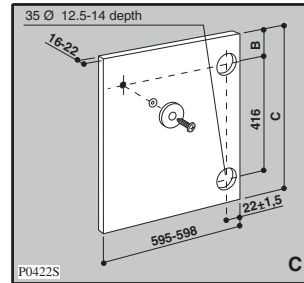

### b) Hinges

To mount the hinges it is necessary to drill two holes (dia. 35 mm, depth 12.5-14 mm depending on the depth of door furniture) on the inner side of the door. The distance between the holes hobs fixing centres must be 416 mm.

The distance (B) from upper edge of the door to the centre of the hole depends on the adjacent furniture's dimensions.

The required dimensions are given in the picture C. The hinges will be fixed to the door by means of screws for wood (2-Fig. B) supplied with the appliance.

### c) Mounting the door

Fix the hinges (1) to the machine by means of the M5x15 screws (3-Fig. B). The hinges can be adjusted to compensate for possible uneven thickness of the door. To align the door perfectly it is necessary to loosen the screw (3-Fig. B), adjust the door and tighten the screw again.

### d) Counter-magnet (6)

The appliance is pre-arranged for a magnetic closure of the door. To enable a correct operation of this device, it is necessary to screw the counter-magnet (6) (steel disk + rubber ring) into the inner side of the door.

Its position must correspond to the magnet (4) on the appliance (see picture D).

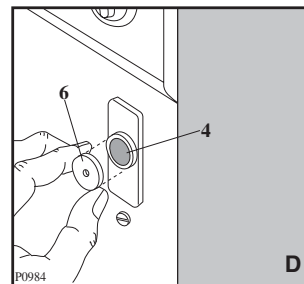

If the door has to be opened from left to right, invert the position of the plates (7), the magnet (4) and the plate (5) (Fig. B and E). Mount the counter magnet (6) and the hinges (1) as previously described

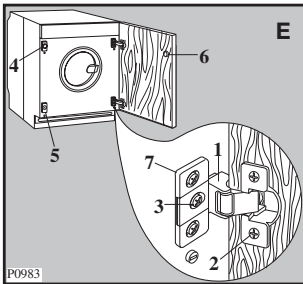

## Recommendations regarding the construction and fitting of a base when the installation requires an integrated appliance to be raised

Where the appliance has been raised by mounting onto a wooden base provided by the installer. The material used to construct the base should have a non slip surface, be water repellent and if possible be one solid piece.

If it is not possible to use one solid piece, due to the additional height required, ensure that any additional strips of timber are glued and screwed to the underside of the base (see Fig. F).

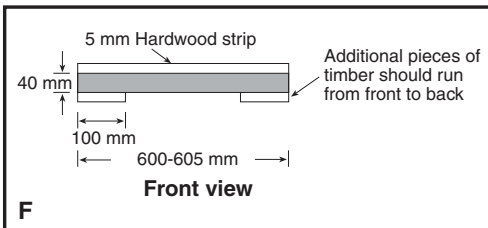

Drill four fixing holes see Fig. G

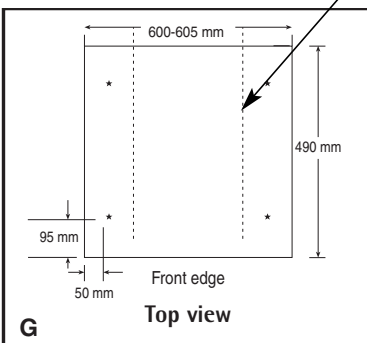

Position the base into the recess with its front edge as far forward as the adjoining plinth line will allow.

**The reason for placing the base in this position is to allow a small strip of beading to be fitted in front of the appliance feet.**

Fix the base firmly to the floor using four appropriate countersunk screws (see Fig. H).

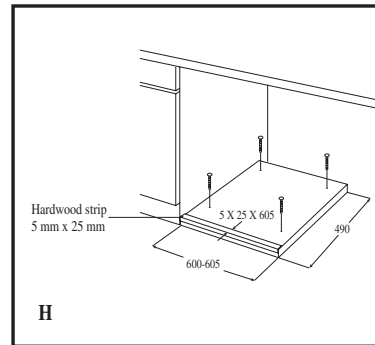

With the appliance installed adjust all four feet ensuring the machine is stable, and a clearance of approximately 5 mm is left between the top of the machine and the underside of the worktop.

A final check for stability should be carried out with the machine on spin with a load, this will identify the need for any further fine adjustment to the feet.

A strip of beading approximately 605 mm W, x 5 mm H, x 25 mm D must be screwed down into the base directly in front of the machine's feet, this will provide additional security.

If required an additional door magnet, part number 1242394-00/3 and disc, part number 1242393-00/5 are available from spare parts.

